

COMMERCIAL
REFRIGERATION



SILENSYS® INVERTER



Precision, Energy Saving, Multi-use

SILENSYS INVERTER

SILENSYS: A REPUTATION BUILT OVER YEARS

Tecumseh offers the widest range of condensing units on the market, from traditional to housed and quiet units to meet all your requirements (small retail outlets, sit down and take-out restaurants, company and mass catering). Tecumseh has developed its expertise by designing high performance solutions over many decades, producing quiet and high quality condensing units. Our SILENSYS range meets the industry's high standards in terms of acoustic performance, reliability and plug and play. Tecumseh is now pleased to offer SILENSYS with a variable capacity solution.

Key features of the product

SILENSYS INVERTER presents the following key features:

- A proven standard Tecumseh reciprocating compressor
- A proven controller with a good notoriety.
- SILENSYS know-how and reliability, state of art product in terms of quality and acoustic.
- Ability to operate in high ambient temperature up to 46°C.
- Easy-to-use: all parameters are pre-set at -10°C evap. and ready to plug.

Markets served by SILENSYS INVERTER

- Frequency variation from 30-60 Hz can supply several cold rooms.
- SILENSYS INVERTER serves specific applications that require either a fine variation of refrigeration production or a large thermal load variations.
- SILENSYS INVERTER brings a major improvement to the fine-tuning of regulation. ON/OFF is replaced by the variable speed control.

SILENSYS INVERTER energy efficiency and environmental impact

- The stability of the evaporation pressure allows energy savings up to 25% with less icing (defrost cycle) of the evaporator and through better stability of the evaporation pressure.
- The equipment is selected with the maximum heat load, which is real only a few days per year.
- To evaluate energy performance, Tecumseh takes into account the variations of thermal loads throughout the year.
- The stability of the evaporation pressure maintains the COP of the compressor and explains the energy saving of the installation.

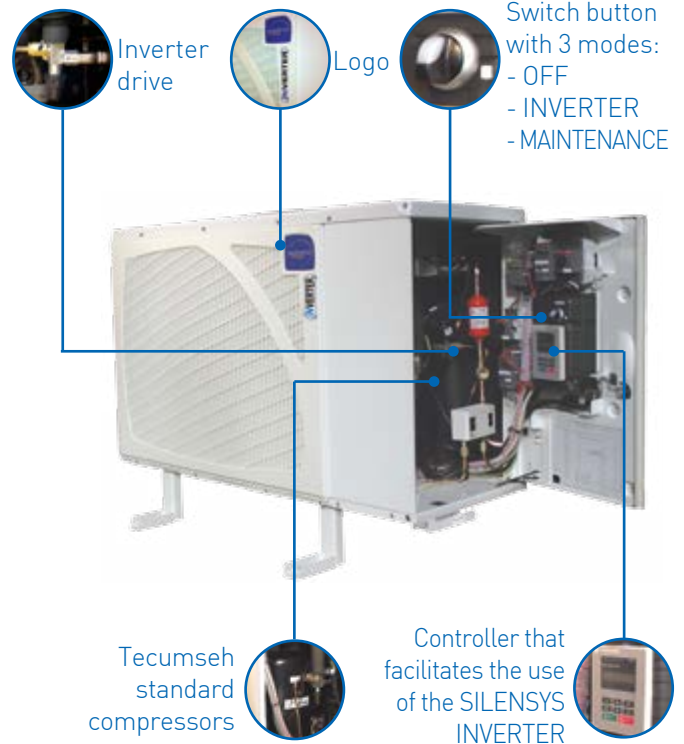

A full range

R404A 9 models at -10°C evaporating temp.

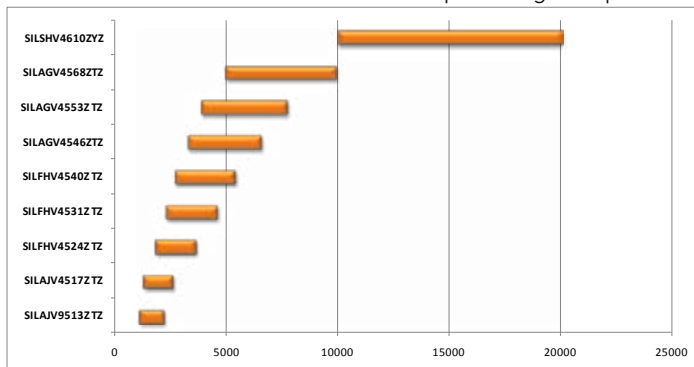

Cooling performance (Watts) EN13215 at 32°C ambient, superheat 10K, sub-cooling 3K.

R134a 6 models at -10°C evaporating temp.

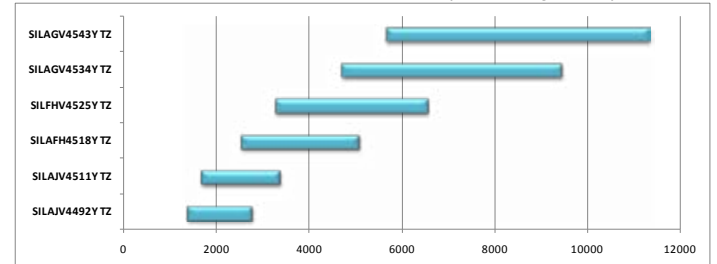

Cooling performance (Watts) EN13215 at 32°C ambient, superheat 10K, sub-cooling 3K.

SILENSYS INVERTER KEY BENEFITS

Energy saving

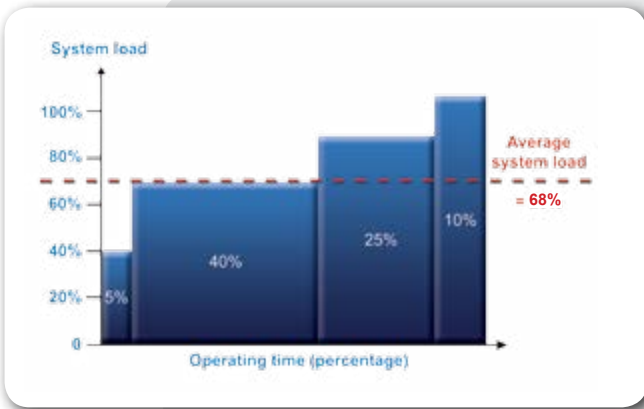

Low operating cost

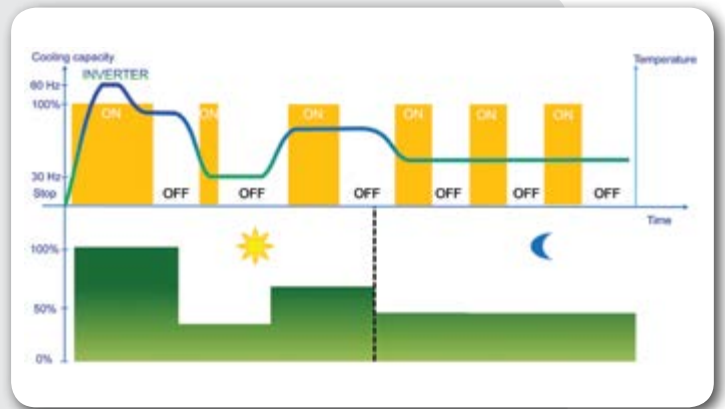

SILENSYS INVERTER will meet the system cooling demand. Consequently, average energy consumption during the operation time will be reduced up to 25%.

Accurate regulated temperature

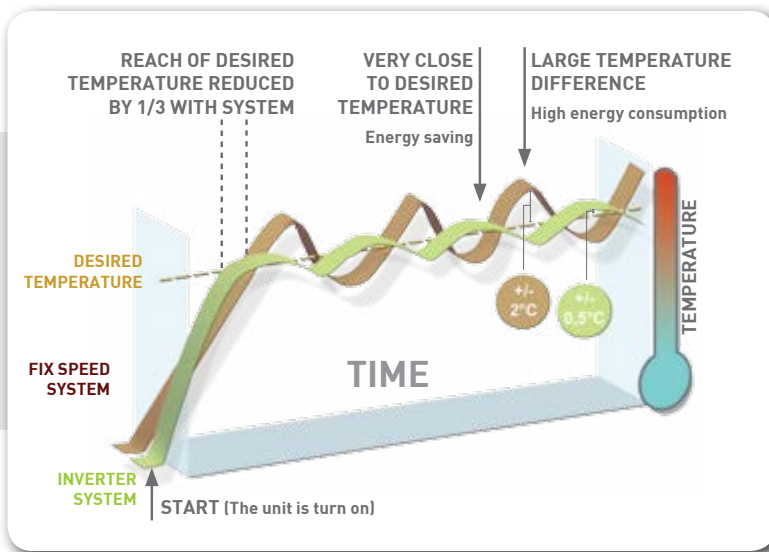

SILENSYS INVERTER is the best solution to fine-tune the needed temperature and hydrometry in your cold room. The better system control will avoid any ambient fluctuations to improve fresh food or goods lifetime and quality.

Multiple cold rooms

Just one SILENSYS INVERTER will allow you to manage many cold rooms. refer to page 5: **SELECTION TOOLS**

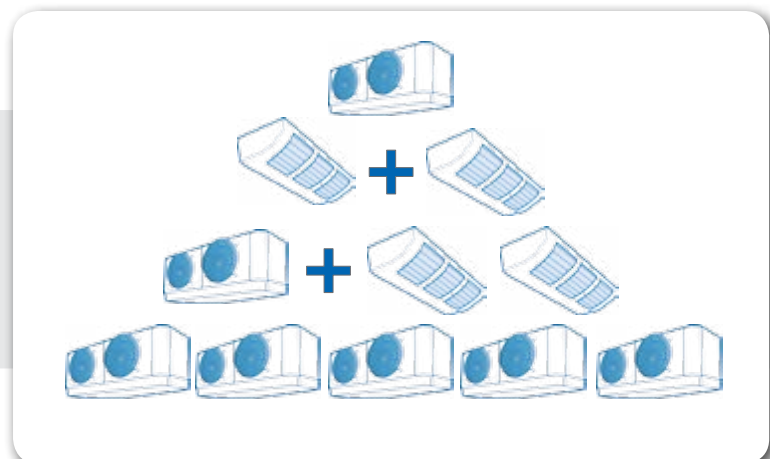

Plug and Play

- Connect the pressure sensor on the compressor valve
- Turn ON (Auto position, factory pre-set at -10 ° C for refrigerants R404A and R134a)
- Follow the installation guide to fine tune the factory setting (Set point, inside the authorized range)

Key benefits



Increased safety

- The speed variation is limited from 30 to 60 hertz in order to secure the compressor, motor and electrical components
- 2 modes: INVERTER with capacity variation or ON/OFF regulation
- Ability to operate in high ambient temperature through the condenser (HTA)*
- Low noise and vibration
- Oil return (Optional)



Easy maintenance and customer service

- Assembly time
- Reduction of components
- A Tecumseh Europe dedicated technical support
- Technicians are trained and in contact with Inverter experts



Installation speed

- Ergonomics in the installation
- Assembly time
- Reduction of components
- A plug and play solution to save installation time and maintenance

* HTA : High Temperature Ambient



DIFFERENTS BENEFITS FOR DIFFERENTS STAKEHOLDERS

For the end customer

SILENSYS INVERTER offers the following benefits to the final customer:

- A lower cost in the case of multiple cold room
- A lower installation cost due to the reduced number of components
- An operating cost with a possible savings of up to 25%
- A quiet condensing unit for facilities in urban areas

For the installer

SILENSYS INVERTER offers the following benefits to the installer:

- A condensing unit type "Plug & Play" with a limited number of connections and wiring.
- A condensing unit that offers the reliability of a standard Tecumseh compressor
- A standard compressor available in wholesale networks
- A decreased number of condensing units installed reduces maintenance. To get the expected gains, do not oversize the unit.

QUICK SELECTION GUIDE:

2 evaporators

1st configuration:
Having slightly different
cooling capacities, (up to 30%)

Example: at 20% Delta 0,84kW and 0,67kW → 1,51kW needed*

Use the correcting factor** of 0,9 → 1,36kW to select the SILENSYS INVERTER



Model	Cooling capacity	Comments
SIL AJV 4492Y	60Hz → 1,36kW	SILENSYS INVERTER matches the capacity requirement with longer runtime expected
	34Hz → 0,84kW	SILENSYS INVERTER matches the capacity requirement
	30Hz → 0,74kW	9% Delta between lowest cooling demand and SILENSYS INVERTER smallest capacity: The condensing unit will run less

3 evaporators

Each one will have
the same cooling capacity

Example: 2,4kW + 2,4kW + 2,4kW → 7,2kW needed*

Use the correcting factor** of 0,85 → 6,12kW to select the SILENSYS INVERTER



Model	Cooling capacity	Comments
SIL AGV 4546Z	60Hz → 6,12kW	SILENSYS INVERTER matches the capacity requirement with longer runtime expected
	43Hz → 4,8kW	SILENSYS INVERTER matches the capacity requirement
	30Hz → 3,48kW	31% Delta between lowest cooling demand and SILENSYS INVERTER smallest capacity. A pressure control valve is needed to keep constant evaporating pressure

- When the smallest evaporator runs alone, the evaporating temperature will be stabilized around -13°C (-3K)
- When a SILENSYS INVERTER feeds 3 evaporators or 2 evaporators having 30% of capacity difference, the suction pressure captured by the pressure sensor will be stabilized around -18°C (-8K). To keep the evaporating pressure constant and the humidity level (flower, fresh meat conservation) inside the cold room, it will be helpful to install an evaporating pressure control valve.
- Because of suction pressure drop, adjust the P1-04 and P1-06 parameter under the estimate suction pressure to avoid cut out during winter time.

2 evaporators

2nd configuration:
With the same cooling capacity

Example: 2 x 4,6kW = 9,2kW, needed*



Model	Cooling capacity	Comments
SIL AGV 4568Z	60 Hz → 9,16kW	SILENSYS INVERTER matches the capacity requirement
	30Hz → 5,3kW	13% Delta between lowest cooling demand and SILENSYS INVERTER smallest capacity: The condensing unit will run less

4 evaporators and more

Example: 3kW + 3kW x 2kW → 8kW, or 6 x 1,5kW → 9kW needed*

Use the correcting factor** of 0,8 → 7,2kW, select the SILENSYS INVERTER: SILAGV 4553Z TZ

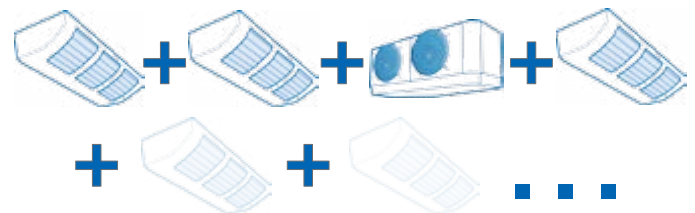

- Caution: Regulation and use will ensure that the minimum duty will be equal or higher than 70% of the SILENSYS INVERTER cooling capacity at 30Hz.
- Because of suction pressure drop, adjust the P1-04 and P1-06 parameter under the estimate suction pressure to avoid cut out during winter time.

w*: Operating conditions: T_{evap}: -10°C, 32°C ambient temperature, 16h working per day, Super heat 10K subcooling 3K EN13215

**:	Number of room	Correcting factors	Rules	Inverter program necessary setting : P1-04 and P1-06
	1	None		
	2	0,9 [dépend of the capacity balance]	the minimum duty will be equal or higher than 80% of the SILENSYS INVERTER cooling capacity at 30Hz.	Yearly lowest suction pressure estimation
	3	0,85	the minimum duty will be equal or higher than 70% of the SILENSYS INVERTER cooling capacity at 30Hz.	Yearly lowest suction pressure estimation
	4	0,8	the minimum duty will be equal or higher than 70% of the SILENSYS INVERTER cooling capacity at 30Hz.	Yearly lowest suction pressure estimation

Correcting factors are made to compensate for the worst condition of calculation.

SILENSYS INVERTER TECHNICAL DATA

R-404A

COMMERCIAL POSITIVE REFRIGERATION

Cooling capacity (W), EN 13215, Ambient temperature 32°C, superheating 10K, subcooling 3K, R404A*

Model	BOM	Ambient temp.	Frequency	Cooling capacity (W)						Absorbed power (W)			Pre setting of the inverter (P1-03) Suction pressure reference	
		°C	Hz	Evaporating temperature (°C)						Evaporating temperature (°C)				
				-20	-15	-10	-5	0	5	10	-15	0		10
SIL AJV 9513 Z	S991330242	32	30	703	922	1173	1460	1784	2147	2553	566	686	727	-10°C 3,4 bar
			60	1280	1660	2090	2572	3108	3705	4369	1163	1580	1849	
		43	30	488	671	880	1116	1382	1679	2012	579	736	802	
			60	889	1208	1563	1956	2391	2872	3408	1193	1712	2049	
SIL AJV 4517 Z	S993030242	32	30	831	1072	1346	1655	2002	2388	2820	748	883	939	
			60	1507	1924	2387	2904	3482	4132	4864	1487	1975	2319	
		43	30	618	829	1066	1331	1627	1958	2328	783	941	1013	
			60	1122	1484	1883	2325	2818	3371	3999	1566	2123	2514	
SIL FHV 4524 Z	S993530242	32	30	1122	1495	1925	2411	2953	3554	4216	1099	1348	1437	
			60	2036	2680	3400	4203	5095	6087	7192	2107	2928	3447	
		43	30	766	1084	1450	1863	2325	2837	3403	1103	1399	1520	
			60	1396	1943	2553	3231	3986	4827	5771	2119	3064	3666	
SIL FHV 4531 Z	S993730242	32	30	1506	1957	2466	3036	3672	4378	5163	1276	1581	1727	
			60	2706	3465	4295	5212	6234	7383	8687	2639	3684	4446	
		43	30	1079	1474	1916	2410	2957	3566	4245	1279	1635	1815	
			60	1944	2606	3323	4110	4985	5971	7099	2649	3828	4678	
SIL FHV 4540 Z	S993830242	32	30	1828	2356	2941	3587	4293	5066	5913	1704	2103	2296	
			60	3240	4095	5005	5992	7082	8308	9708	3577	4961	5980	
		43	30	1417	1890	2415	2992	3625	4317	5079	1731	2141	2341	
			60	2518	3282	4098	4987	5976	7099	8398	3636	5057	6100	
SIL AGV 4546 Z	S995130242	32	30	2011	2694	3485	4381	5381	6486	7700	1802	2312	2548	
			60	3634	4801	6110	7554	9130	10839	12690	3638	5290	6444	
		43	30	1352	1918	2580	3336	4186	5132	6181	1763	2344	2627	
			60	2458	3428	4527	5748	7089	8551	10149	3556	5382	6653	
SIL AGV 4553 Z	S995230242	32	30	2402	3190	4100	5131	6285	7562	8970	2016	2571	2844	
			60	4336	5678	7181	8844	10668	12660	14836	4105	5925	7245	
		43	30	1672	2340	3115	3995	4982	6079	7293	1994	2633	2961	
			60	3035	4177	5462	6887	8454	10173	12061	4062	6093	7554	
SIL AGV 4568 Z	S995430242	32	30	3346	4239	5302	6522	7892	9403	11051	2494	3187	3591	
			60	5972	7456	9164	11081	13198	15509	18021	5140	7437	9267	
		43	30	2422	3220	4161	5235	6435	7752	9188	2544	3317	3774	
			60	4336	5659	7173	8869	10737	12775	14994	5257	7776	9753	
SIL SHV 4610 Z	S999000242	32	30	6636	8334	10257	12415	14814	17464	20373	4480	5018	5534	
			60	12038	14666	17251	19800	22326	24855	/	8175	10593	/	
		43	30	4889	6383	8059	9925	11992	14272	16782	4177	5636	6362	
			60	9496	11929	14259	16486	18618	/	/	7678	11581	/	

*: Cooling capacity is given for information purpose and may change, without prior notice, with improvement that Tecumseh Product Company is permanently making to its products.



CUSTOMER SERVICE

- A Tecumseh Europe dedicated technical support
- Technicians are trained and in contact with INVERTER experts

R-134a

COMMERCIAL POSITIVE REFRIGERATION

Cooling capacity (W), EN 13215, Ambient temperature 32°C, superheating 10K, subcooling 3K, 3 PHASES, R134a*

Model	BOM	Ambient temp. °C	Frequency Hz	Cooling capacity (W)							Absorbed power (W)			Pre setting of the inverter (P1-03) Suction pressure reference
				Evaporating temperature (°C)							Evaporating temperature (°C)			
				-20	-15	-10	-5	0	5	10	-15	0	10	
SIL AJV 4492 Y	S990930242	32	30	384	549	738	956	1204	1486	1804	348	417	449	-10°C 1 bar
			60	714	1015	1359	1747	2182	2666	3204	684	926	1102	
		43	30	275	426	597	790	1008	1254	1531	352	446	494	
			60	512	787	1096	1440	1820	2239	2700	695	684	1221	
SIL AJV 4511 Y	S991030242	32	30	538	727	947	1199	1484	1804	2163	471	587	659	
			60	991	1331	1719	2155	2642	3181	3774	950	1343	1670	
		43	30	422	591	785	1006	1255	1534	1846	488	628	716	
			60	778	1081	1423	1806	2229	2695	3206	988	1449	1820	
SIL FHV 4518 Y	S993430242	32	30	772	1045	1377	1771	2233	2769	3384	724	785	821	
			60	1425	1913	2495	3179	3974	4889	5938	1435	1736	2000	
		43	30	351	622	940	1308	1732	2218	2771	730	795	835	
			60	656	1148	1712	2356	3088	3918	4859	1448	1764	2037	
SIL FHV 4525 Y	S993630242	32	30	1085	1446	1863	2341	2885	3502	4198	785	910	976	
			60	1982	2617	3335	4143	5050	6066	7204	1566	2043	2418	
		43	30	722	1051	1430	1864	2357	2917	3553	774	921	1002	
			60	1328	1911	2566	3299	4120	5040	---	1543	2075	---	
SIL AGV 4534 Y	S994830242	32	30	1188	1693	2311	3049	3916	4921	6076	1259	1551	1703	
			60	2203	3116	4213	5509	7018	8756	10744	2451	3428	4168	
		43	30	851	1248	1748	2361	3094	3958	4965	1223	1582	1779	
			60	1584	2306	3196	4268	5536	7020	8739	2375	3518	4368	
SIL AGV 4543 Y	S995030242	32	30	1673	2318	3075	3951	4956	6101	7398	1530	1958	2202	
			60	3082	4233	5559	7071	8783	10712	12879	3039	4429	5516	
		43	30	1132	1685	2334	3088	3956	4949	6082	1507	2013	2307	
			60	2094	3087	4226	5522	6989	8645	10512	2993	4578	5795	

*: Cooling capacity is given for information purpose and may change, without prior notice, with improvement that Tecumseh Product Company is permanently making to its products

Acoustics, Dimensions, Connections

A higher performance with a low noise level

	Models	I _{max} C.U.(60 Hz)	Weight		Acoustic pressure	Receiver Volume	Diameter of connection		Fan		Fan absorbed power	Fan voltage
		I _{max}	Net	Gross	10m**	L	Suction	Liquid	Nbr	Diam.	Per fan	V
		A	Kg	Kg	dB(A)		∅"	∅"	mm	W		
R134a	SIL AJV 4492 Y TZ	5,1	73	93	30	1,5	1/2	3/8	1	360	65	230
	SIL AJV 4511 Y TZ	7,2	74	94	30	1,5	5/8	3/8	1	360	65	230
	SIL AFH 4518 Y TZ	8,3	82	106	34	2,35	5/8	1/2	1	450	126	230
	SIL FHV 4525 Y TZ	12,3	86	108	36	2,35	5/8	1/2	1	450	126	230
	SIL AGV 4534 Y TZ	22,2	133	108	39	6	7/8	3/8	2	450	126	230
	SIL AGV 4543 Y TZ	22,2	133	148	39	6	7/8	3/8	2	450	126	230
R404A	SIL AJV 9513 Z TZ	8,3	76	96	31	1,5	5/8	3/8	1	360	65	230
	SIL AJV 4517 Z TZ	8,3	75	97	36	2,35	5/8	3/8	1	450	126	230
	SIL FHV 4524 Z TZ	12,3	86	111	37	2,35	5/8	1/2	1	450	126	230
	SIL FHV 4531 Z TZ	22,2	92	114	41	3,9	7/8	1/2	1	450	126	230
	SIL FHV 4540 Z TZ	22,2	92	114	39	3,9	7/8	1/2	1	450	126	230
	SIL AGV 4546 ZTZ	22,2	133	148	37	6	7/8	5/8	2	450	126	230
	SIL AGV 4553 Z TZ	27	139	154	37	6	7/8	5/8	2	450	126	230
	SIL AGV 4568 Z TZ	27	143	158	37	6	1 1/8	5/8	2	450	126	230
	SIL SHV 4610 Z YZ	27	270	289	48	9,5	1 1/8	5/8	2	500	180	230

** : Acoustic pressure at 50Hz with maximum fan speed

Electrical drawings

DE8521 SIL FH ... Y/Z TZ (INVERTER)

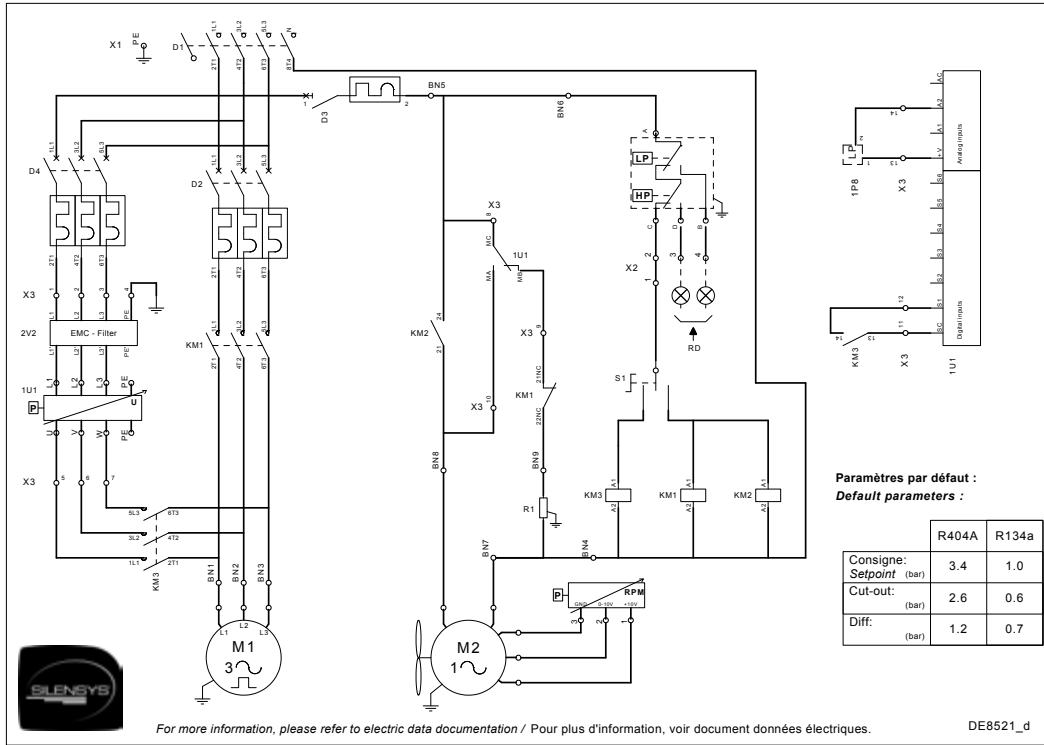

DE8523 SIL SHV 4610 ZYZ

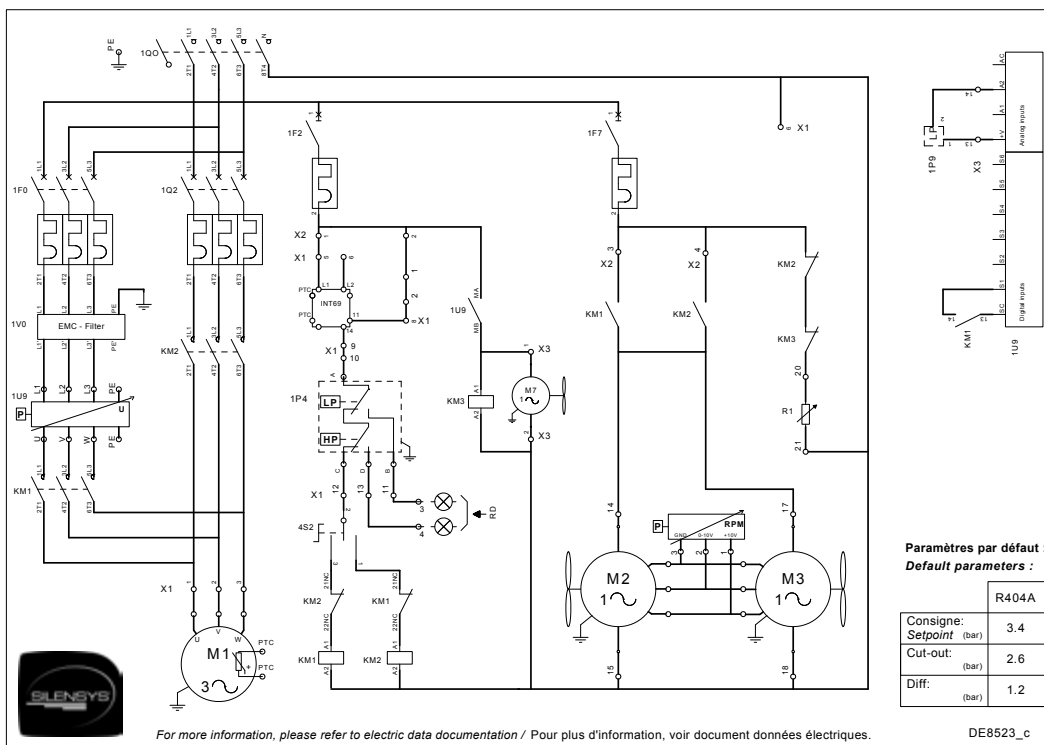

Drawing Number	Reference
DE8520*	SIL AJV 9513 Z TZ SIL AJV 4492 Y TZ SIL AJV 4511 Y TZ
DE8521	SIL FHV 4524 Z TZ SIL FHV 4531 Z TZ SIL FHV 4540 Z TZ SIL FHV 4518 Y TZ SIL FHV 4525 Y TZ
DE8522*	SIL AGV 4546 Z TZ SIL AGV 4553 Z TZ SIL AGV 4568 Z TZ SIL AGV 4534 Y TZ SIL AGV 4543 Y TZ
DE8523	SIL SHV 4610 Z YZ
DE8524*	SIL AJV 4517 Z TZ

* Drawing available on request

Dimensions & Packaging

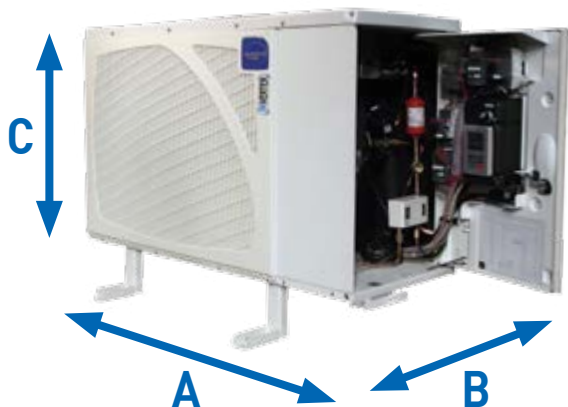

Sizes	A	B	C
S	930 mm	575 mm	690 mm
M	1145 mm		1315 mm
L	1615 mm		1300 mm
XL	1615 mm		1300 mm

Spare parts reference and sizes

	Product Model Number	Reference	INVERTER spare part code	Size
R-404A	SIL AJV 9513 Z TZ	S991330242	8580105	S
	SIL AJV 4517 Z TZ	S993030242	8580105	M
	SIL FHV 4524 Z TZ	S993530242	8580106	M
	SIL FHV 4531 Z TZ	S993730242	8580120	M
	SIL FHV 4540 Z TZ	S993830242	8580120	M
	SIL AGV 4546 Z TZ	S995130242	8580102	L
	SIL AGV 4553 Z TZ	S995230242	8580118	L
	SIL AGV 4568 Z TZ	S995430242	8580104	L
	SIL SHV 4610 Z YZ	S999000242	8580109	XL
	R-134a	SIL AJV 4492 Y TZ	S990930242	8580112
SIL AJV 4511 Y TZ		S991030242	8580114	S
SIL FHV 4518 Y TZ		S993430242	8580116	M
SIL FHV 4525 Y TZ		S993630242	8580107	M
SIL AGV 4534 Y TZ		S994830242	8580103	L
SIL AGV 4543 Y TZ		S995030242	8580103	L
Controller for all models		-	8586050	-

Packaging

- High quality
- Similar Packaging of SILENSYS
- Dedicated Palets
- Forklift Standard indication
- Easy to unpack
- Tiltwatch®* on S and M size



*Tiltwatch : Turns red if the package it is affixed to is tilted past 80° or is completely up-ended. However, it remains unaffected by movement due to normal handling conditions.

SALES AND MARKETING HEAD OFFICE

2, avenue Blaise Pascal
Bât. B
38 090 Vaulx-Milieu
France
Tel. int +33 (0)4 74 82 24 00
Fax int +33 (0)4 74 82 24 44

GERMAN OFFICE

Ludwigstrasse 31
60 327 Frankfurt am Main
Germany
Tel. int +49 (0)69 97 1454-0
Fax int +49 (0)69 72 41053

ITALIAN OFFICE

Via Parco Abbaziale, 6
10 094 Giaveno (TO)
Italia
Tel. int +39 (0)11 937 98 61
Fax int +39 (0)11 937 83 88

SPANISH OFFICE

C/Corcega 301-303, 2º, 3a
08 008 Barcelona
España
Tel. int +34 93 218 5708
Fax int +34 93 218 1691

BRITISH OFFICE

One Victoria Square
B1 1BD Birmingham
United Kingdom
Tel. int + 44 (0) 121 632 2900
Fax int +33 (0)4 74 82 24 94

MALAYSIAN OFFICE

Nº 18 Jalan Sultan Mohamed 4
Selat Klang Utara
42 000 Port Klang
Selangor Darul Eshan
Malaysia
Tel. int +60 3 3176 3886
Fax int +60 3 3176 3890

sales&marketing@tecumseh.com



Tecumseh Europe : the commercial refrigeration specialist

Tecumseh Europe, a major player in the refrigeration and climatic comfort industry, is a subsidiary of the American group Tecumseh Products Company. As a human-sized international company, Tecumseh Europe designs and manufactures compressors and condensing units using new technologies, which positions it as the leader in commercial refrigeration. Today, about 25% of global food consumption is spoiled due to non-compliance with the cold chain. Facing this reality, Tecumseh aims to offer a range of high added-value products and services.

■ Values in the service of customers and the company

For 80 years, Tecumseh's success has been based on key values shared by its managers and all its employees:

- the human value: the people that make up the company
- the actual customer orientation and the place given to its customers
- the importance of the quality of services and products offered
- the permanent technological innovation.

■ The people: most important resource of the company

This value can be seen especially in the professionalism of each employee, all of whom have significant technical and commercial skills as well as a real industrial dimension.

The development of skills by in-house training and promotion aims to involve employees to a greater degree.

■ Innovative products

Since 1934, Tecumseh has been committed to developing products using innovating technologies that guarantee low energy consumption as well as a high level of reliability. Today, Tecumseh is the only company that offers its customers the 3 technologies used in a hermetic compressor: **Reciprocating, Rotary and Scroll.**

Internationally recognised, the benchmark brands of the Group such as L'Unité Hermétique®, Silensys®, Wintsys®, Masterflux®, Celseon®, and Vector® **form part of the pillars of the refrigeration industry thanks to a strong distribution network with thousands of points of sale on all 5 continents.**

■ Tecumseh also offers service

Tecumseh offers a complete assistance service from the selection of products, **design, and training**, to **on-site** technical assistance by a high-performance Sales Administration department.

■ Tecumseh: the desire to propose a green offer

Being aware of the future economic and ecological demands, **the company is committed to sustainable development by offering products that use the refrigeration fluids** in phase with the current market. Because it follows a rigorous approach of continuous improvement, Tecumseh works according to the **ISO 14001** certification (environmental management system) as well as standard **ISO 9001** for its quality management system.

With more than 1,350 employees, Tecumseh Europe focuses on innovation, quality of the products with complete solutions. At present and for the foreseeable future, the company is the best supplier of 100% customer-oriented commercial refrigeration.



«L'Unité Hermétique», a Tecumseh brand internationally recognised by professionals in the cooling industry, stands for reliability, expertise and skill. Tecumseh offers solutions labeled «Expertise L'Unité Hermétique», referencing the performance of the historical benchmark of the refrigeration market on all 5 continents.



Silensys Inverter
catalog EN 11/2014



accitudes.com - Photos © Tecumseh - © Thinkstock - © Héroïse Peyre, Jean-Philippe Darbois.



Tecumseh

Cooling for a Better Tomorrow™

www.tecumseh.com